



VipacBoard

Fixing Instructions

PCS
High
Performance
Construction
Products

VipaBoard

Fixing Instructions

Contents

Structure Preparation

1. VipaBoard Surface Preparation & Fixing Overview
2. Fixing to Timber Floors
3. Fixing to Solid Floors
4. Fixing to Internal Stud Framework
5. Fixing to External Stud Framework
6. Fixing to Masonry Walls

Surface Preparation

7. Taping Joints, Abutments and Fixings
8. PCS Waterproofing Paste
9. Expansion/Movement Joints
10. VipaBoard with Soft Floor Finishes
(Carpet, Vinyl floors, Vinyl tiles, Karndean, Amtico etc)
11. VipaBoard with Wood Planking/Laminate Planking Floor Finishes
(Floating Floor)
12. VipaBoard with Solid Wood Planking/Wood Blocks
(Solid Floor)
13. VipaBoard with Under Floor Heating
14. Tile Choice for Floors
15. Tile fixing to Walls
16. Plastering
17. Flexible Synthetic Render Systems

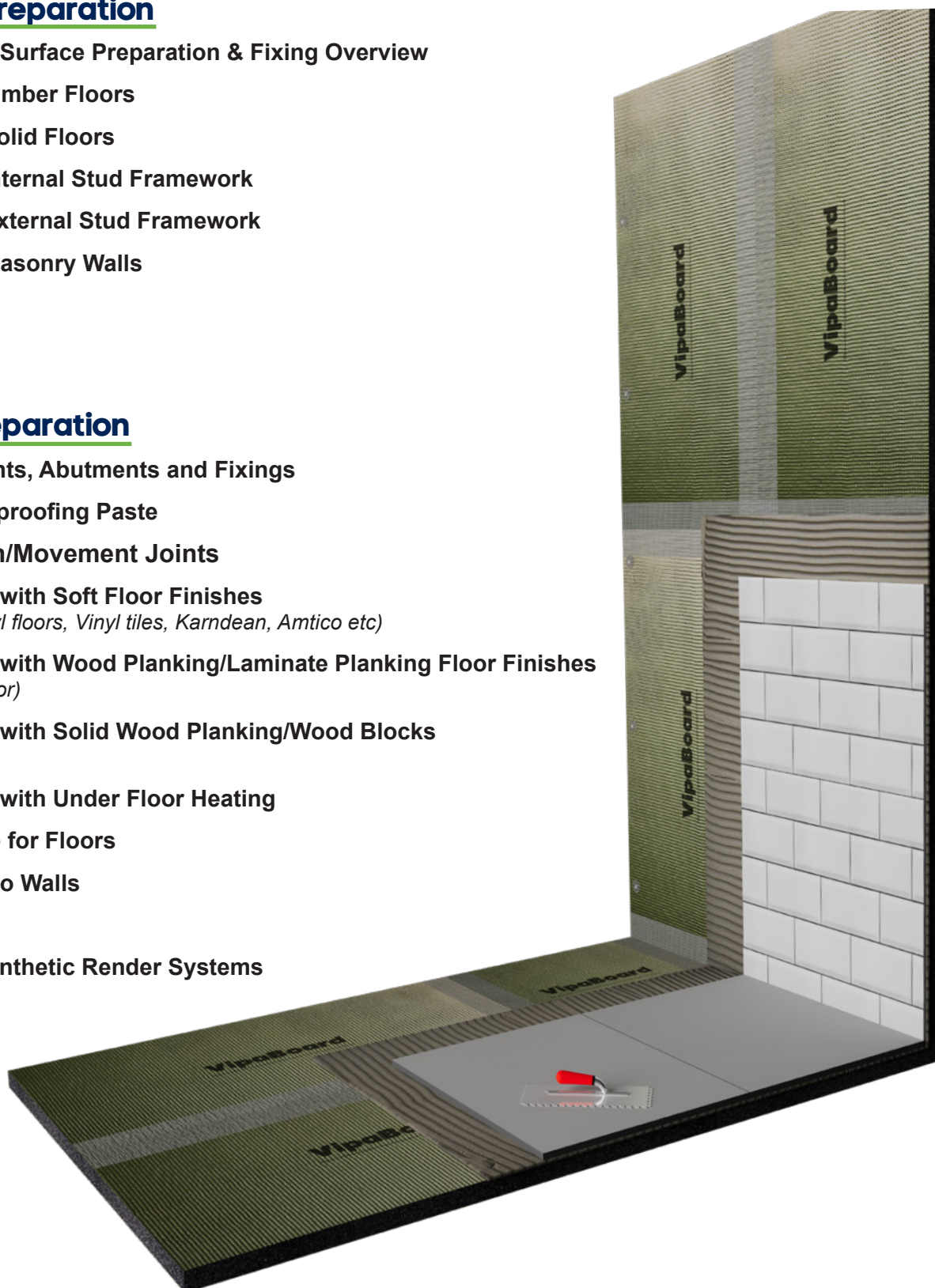

1. VipaBoard Surface Preparation

NOTE: VipaBoard is not compatible with solvent based adhesives.

It is very important to read the surface preparation notes set out in this document prior to installation of the VipaBoard. The advisory points below provide a quick overview for the preparation of the VipaBoard surface prior to applying floor finishes.

- I. For Soft floor finishes e.g. Vinyl & Carpet, it is essential to cover the VipaBoard surface with a minimum 10mm thick, flexible, cement-based levelling screed.
- II. Wood planking and Wood Laminate can be fitted directly over the VipaBoard surface, however, for commercial projects subject to heavy foot traffic, we recommend covering the surface of the VipaBoard with a minimum 10mm thick, flexible, cement-based levelling screed.
- III. For Solid Wood fixed with adhesive, the surface of the VipaBoard must be covered with a minimum 10mm thick cement-based, flexible, levelling screed.
- IV. Porcelain, natural stone and ceramic tiles, can be applied directly onto the surface of the VipaBoard, however, for commercial projects, subject to heavy loads, we recommend covering the surface of the VipaBoard with a minimum 10mm thick, flexible, cement-based levelling screed, prior to fixing tiles.
- V. VipaBoard is compatible for use with highly flexible synthetic render systems. Traditional sand/cement render types are not compatible.

Refer to additional surface preparation notes set out in this document for more detailed information.

Contact PCS Technical for advice on structures, applications and surface finishes not covered in this document.

Internal Stud Frame & Timber Floor Construction

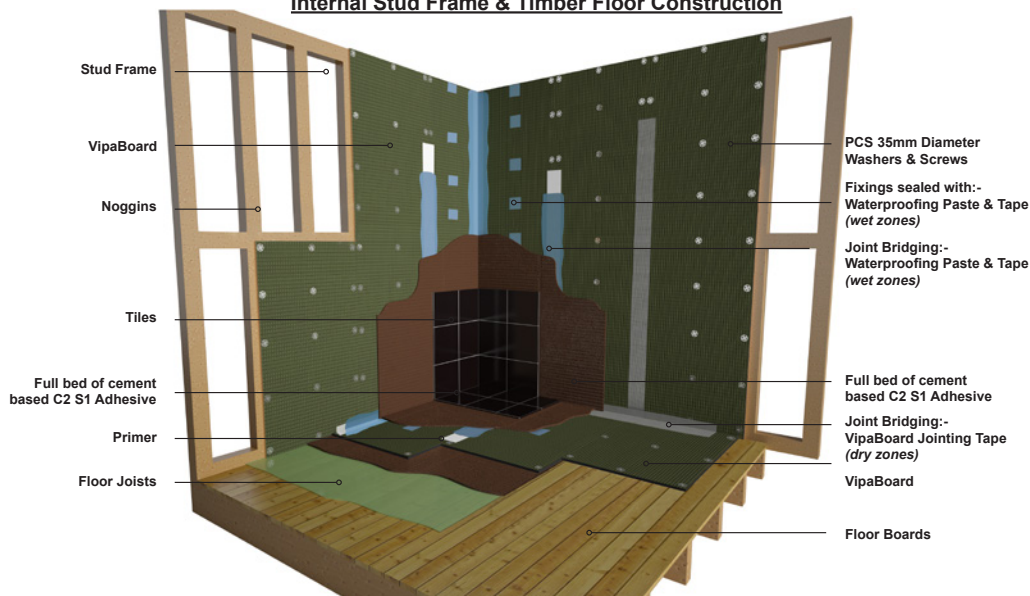

Internal Masonry Wall & Solid Floor Construction

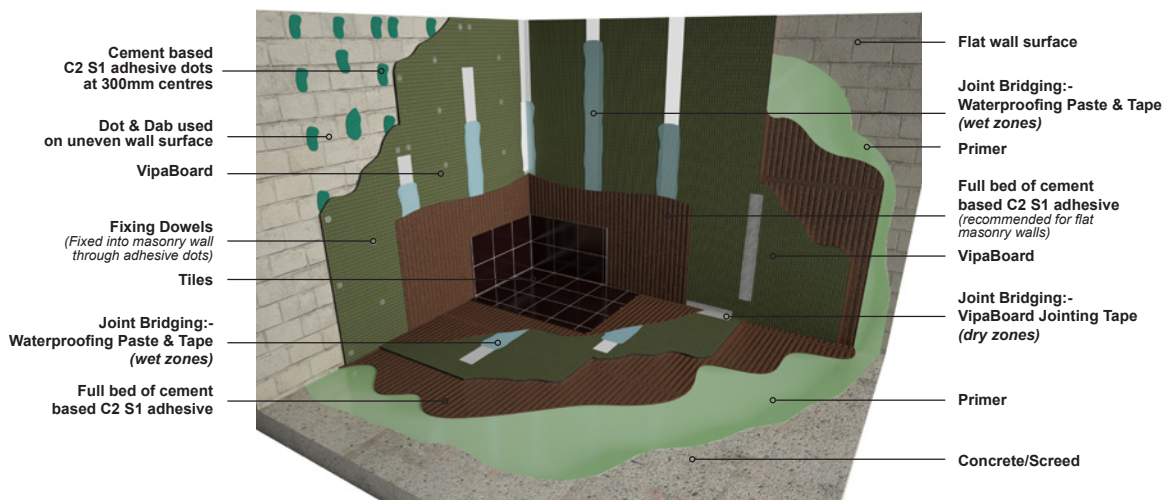

Building Regulations

All information is given as guidance and if adhered to will perform as intended. We fully guarantee the quality of our products, however, as we do not have knowledge of site conditions or the capability of the installer, we cannot accept liability for damage which may arise due to a result of incorrect installation. The information and advice provided by PCS does not override nor supersede building regulations. It is the responsibility of the user to seek professional guidance to ensure PCS products are compatible for their intended use and that the products comply with building regulations.

2. Fixing to Timber Floor Boards

Structural Design Consideration:

VipaBoard is NOT designed to be directly fixed onto timber joists, therefore it is essential that all joists are boarded with a suitable flooring material, such as Plywood/Chipboard Planks/T&G boarding etc. before VipaBoard is fitted. The type of boarding used, must comply with current building regulations and approved standards. The floor boarding must be of the correct thickness to resist warping and deflection between joist centres, meet the requirements of BS EN 5385 1,2,3,4,5, code of practice for design and installation of internal floor tiling, and must be able to support the weight of finishes applied and any live loading imposed on the floor in service.

Note: 4mm thick VipaBoard is not suitable for fixing onto timber floor boarding.

VipaBoard 6mm thick and above is suitable for fixing onto timber floor boarding.

2a) Fixing onto timber floor boarding using fixing washers and screws only (no adhesive)

Note: 4mm thick VipaBoard is not suitable for fixing onto timber floor boarding.

VipaBoard 6mm thick and above is suitable for fixing onto timber floor boarding.

VipaBoard can be secured directly to timber floor boarding using 35mm diameter fixing washers and suitable screws with a countersunk head, set at a maximum of 300mm centres (e.g. 15 fixings per 1200mm x 600mm VipaBoard). It is acceptable to fix directly into the floor boarding, however, where possible fix and anchor into the floor joists. It is acceptable to place fixing washers directly along the VipaBoard edge so that the fixing washers can secure adjacent VipaBoard reducing the amount of fixings required. Ensure that the VipaBoard is in full contact with the floor surface and that there is no movement, or hollow spots, between the VipaBoard and the sub floor. Additional fixings can be used to secure the VipaBoard firmly to the floor boarding. If the sub floor is uneven, we would recommend applying adhesive and fixing washers to secure the VipaBoard to the sub floor (referenced in note 2b.)

NOTE: Securing VipaBoard to floor boarding using washers and screws (no adhesive) facilitates easy removal of the VipaBoard from the floor boarding (if required in future years) for refurbishment and modernisation of the flooring.

NOTE: WHEN USING SCREWS TO FIX VIPABOARD MAKE SURE TO AVOID ELECTRICAL CABLES OR PIPEWORK THAT MAY BE CONCEALED

Fixing Coverage Guide

Fixings 21 per m²
(fixing quantities may be reduced if washers are used to span adjacent VipaBoards)

Indicative Fixing Details using washers & screws
(1200mm x 600mm VipaBoard)

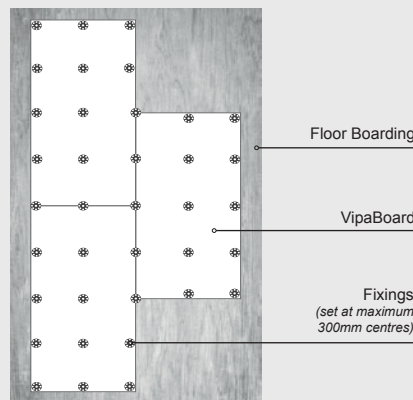

2b) Fixing onto timber floor boarding using cement-based tile adhesive and 35mm diameter fixing washers
(Refer to the adhesive manufacturer's instructions for the preparation and priming of the structural boarding, prior to starting your project)

Note: 4mm thick VipaBoard is not suitable for fixing onto timber floor boarding.

VipaBoard 6mm thick and above is suitable for fixing onto timber floor boarding.

VipaBoard can be fixed using a good quality cement-based, flexible, fast setting tile adhesive that meets classification C2 S1 or above. Check with the adhesive manufacturer for advice on priming the floor boarding. The adhesive should be applied directly onto the floor boarding using an 8-12mm notched tiling trowel. Ensure full adhesive contact with the VipaBoard surface; solvent-based or ready mixed adhesives must NOT be used. Fix the VipaBoard in a brick bond style, abutting the VipaBoard surface with adjacent VipaBoard as you proceed. Apply pressure to the VipaBoard surface, making sure there is good compaction of the VipaBoard into the adhesive, and that no hollow spots remain under the VipaBoard.

In addition to the adhesive layer, VipaBoard must also be secured to the floor boarding with 35mm diameter fixing washers and a suitable screw with a countersunk head. Fix the washers to the VipaBoard once the adhesive has set. It is acceptable to fix directly into the floor boarding, however, where possible fix and anchor into the floor joists. The spacing for the fixing washers should be set at 400mm - 600mm centres (e.g. 8 fixing washers per 1200mm x 600mm VipaBoard). Position the fixing washers along the VipaBoard edge and also down the centre line of each VipaBoard. The fixing washers placed down the centre of the VipaBoard should be staggered from the VipaBoard edge fixings, creating a crisscross pattern on the VipaBoard surface. It is acceptable to place fixing washers directly along the VipaBoard edge, so that the fixing washers can secure adjacent VipaBoards reducing the amount of fixings required.

Additional fixings can be used to secure the VipaBoard firmly to the floor boarding.

DO NOT ALLOW THE ADHESIVE TO FORM A SKIN AS THIS WILL PREVENT ADHESION.

NOTE: WHEN USING SCREWS TO FIX VIPABOARD MAKE SURE TO AVOID ELECTRICAL CABLES OR PIPEWORK THAT MAY BE CONCEALED

Fixing Coverage Guide	
Adhesive	4.5kg per m ²
Fixings	12 per m ² <i>(fixing quantities may be reduced if washers are used to span adjacent VipaBoards)</i>

Indicative Fixing Detail using adhesive, washers & screws
 (1200mm x 600mm VipaBoard)

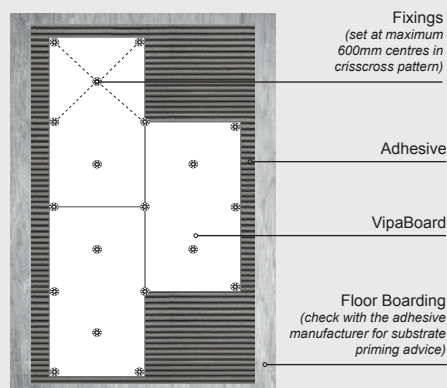

3. Fixing to Solid Floors

- 3a) Fixing onto concrete / cement screed / asphalt and other similar solid substrates using cement-based tile adhesive. For Calcium Sulphate / Anhydrite / Gypsum screeds, advice must be sought from the adhesive manufacturer regarding the preparation of the screed prior to applying fixing adhesive.
(Refer to the adhesive manufacturer's instructions for the preparation and priming of the substrate, prior to starting your project)
Note: VipaBoard of all thicknesses is suitable for fixing onto solid floors.

Prior to fixing the VipaBoard, all traces of grease and loose material must be removed from the floor substrate. Newly poured concrete and screed should be fully cured, and have a moisture reading no greater than 75% Relative Humidity (RH) as per BS5383 prior to fixing the VipaBoard. We recommend sealing any porous floor substrate with a suitable water-resistant primer before adhesive is applied. Fix VipaBoard using a good quality cement-based, flexible, fast setting tile adhesive that meets classification C2 S1 or above.

When fixing VipaBoard to substrates such as Calcium Sulphate, Anhydrite, Gypsum screeds, advice must be sought from the adhesive manufacturer regarding the preparation of the screed prior to applying the adhesive. The adhesive should be applied directly onto the floor using an 8-12mm notched tiling trowel, ensuring full coverage to the VipaBoard surface; solvent-based or ready mixed adhesives must NOT be used. Fix VipaBoard into the adhesive in a brick bond style, abutting the VipaBoard surface with adjacent VipaBoards as you proceed. Apply pressure to the VipaBoard surface making sure there is good compaction of the VipaBoard into the adhesive, and that no hollow spots remain under the VipaBoard.

DO NOT ALLOW THE ADHESIVE TO FORM A SKIN AS THIS WILL PREVENT ADHESION.

Fixing Coverage Guide	
Adhesive	4.5kg per m ²

Indicative Fixing Details using adhesive
(1200mm x 600mm VipaBoard)

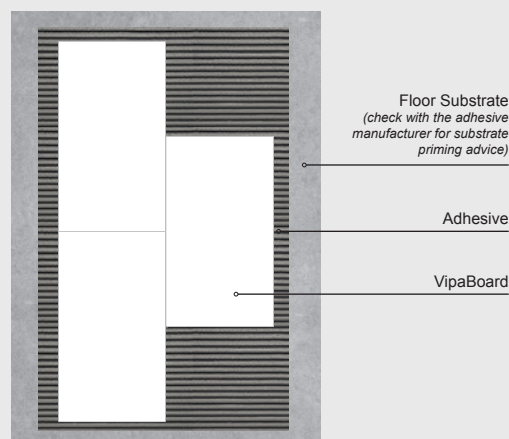

4. Fixing to Internal Stud Framework

Structural design consideration:

Stud framework and any cladding/lining used, must be designed and constructed in accordance with relevant building regulations, and must be able to support the weight of the finishes applied, and any live loading imposed on the framework.

VipaBoard over plasterboard lined stud framework is fixed using the same detail as fixing VipaBoard over unlined studs.

VipaBoard 4mm thick is not suitable for use onto walls.

VipaBoard 6mm thick is not suitable for use over unlined or plasterboard lined stud framework.

VipaBoard 6mm thick is suitable for use over plywood lined stud framework.

VipaBoard 10mm thick and above is suitable for use over unlined and lined stud framework.

4a) Fixing directly onto internal stud framework and onto stud framework lined with plasterboard (Fix using 35mm diameter washers and screws)

Note: VipaBoard must be 10mm thick or greater for use over unlined and plasterboard lined stud framework.

For 10mm thick VipaBoard, vertical studs should be set at maximum 300mm centres.

For 12.5mm thick VipaBoard, vertical studs should be set at maximum 400mm centres.

For VipaBoard 20mm thick and above, stud centres can be set at maximum 600mm centres.

Timber noggins MUST be installed between vertical studs and positioned to support the edges of the VipaBoard.

Fixing washers and screws should be set at maximum 300mm centres on vertical stud framework and also fixed into the intermediate noggins on 600mm stud centres (e.g. 15 fixing per 1200mm x 600mm VipaBoard on 300mm studs, 12 fixing per 1200mm x 600mm VipaBoard on 400mm and 600mm studs)

Additional fixings can be used if required.

Fixing Coverage Guide

Fixings: 21 fixings per m² based on 300mm stud centres for a 10mm thick VipaBoard.
(fixing quantities may be reduced if washers are used to span adjacent VipaBoards)

Fixings: 17 fixings per m² based on 400mm stud centres for a 12.5 mm thick VipaBoard.
(fixing quantities may be reduced if washers are used to span adjacent VipaBoards)

Fixings: 17 fixings per m² based on 600mm stud centres for a 20mm+ thick VipaBoard.
(fixing quantities may be reduced if washers are used to span adjacent VipaBoards)

Stud Framework (unlined)

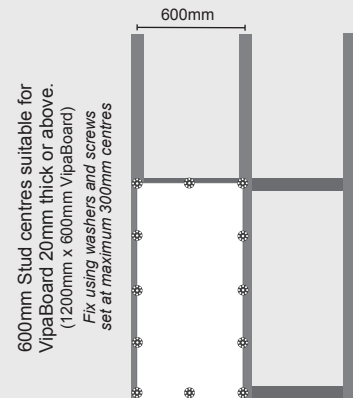
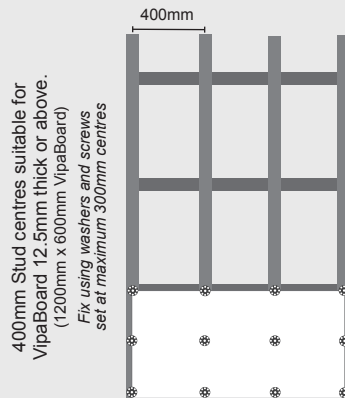
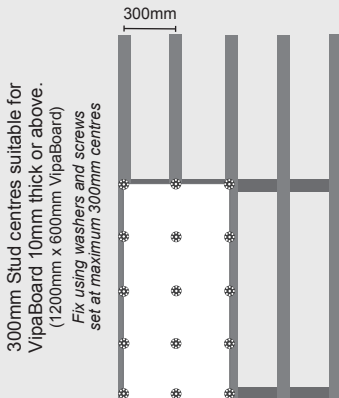

Stud Framework (plasterboard lined)

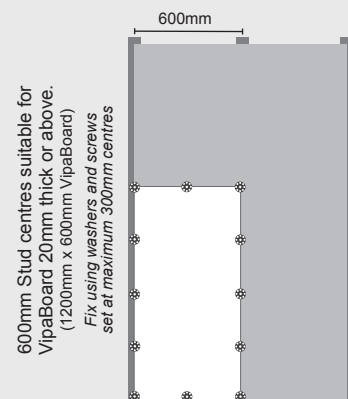
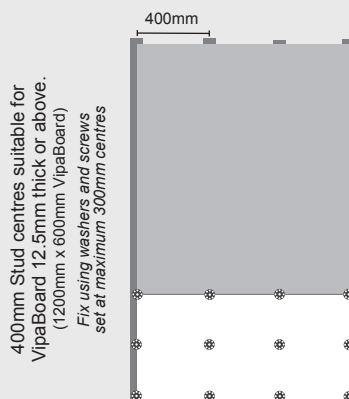
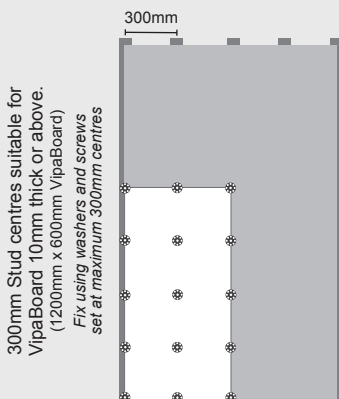

4b) Fixing to Internal stud framework pre lined with Plywood

(Fix using 35mm diameter washers and screws)

Note: 4mm thick VipaBoard is not suitable for fixing onto walls

VipaBoard 6mm thick and above can be fixed over plywood lined stud framework

Studs can be set up to 600mm centres, plywood must be minimum 12mm thick.

Fix 6mm thick VipaBoard with washers and screws set at 200mm centres

(i.e 28 fixings per 1200mm x 600mm VipaBoard)

Fix VipaBoard 10mm thick and above with washers and screws set at 300mm centres

(i.e 15 fixings per 1200mm x 600mm VipaBoard)

It is acceptable to fix directly into the plywood lining, however, where possible fixings should be anchored into the stud framing.

Fixing Coverage Guide

Fixings for 6mm thick VipaBoard:

38 fixings per m²

(fixing quantities may be reduced if washers are used to span adjacent VipaBoards)

Fixings for 10 mm thick VipaBoard:

21 fixings per m²

(fixing quantities may be reduced if washers are used to span adjacent VipaBoards)

6mm VipaBoard fixed horizontally over plywood lined studs set at 400mm centres.
(1200mm x 600mm VipaBoard)

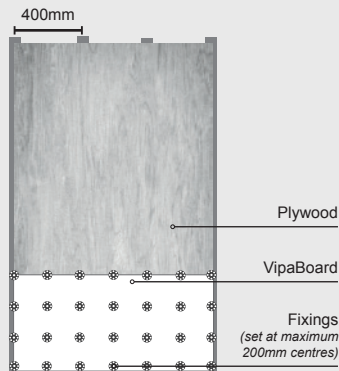

6mm VipaBoard fixed vertically over plywood lined studs set at 400mm centres.
(1200mm x 600mm VipaBoard)

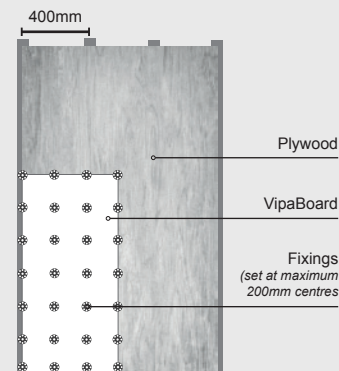

6mm VipaBoard fixed vertically over plywood lined studs set at 600mm centres.
(1200mm x 600mm VipaBoard)

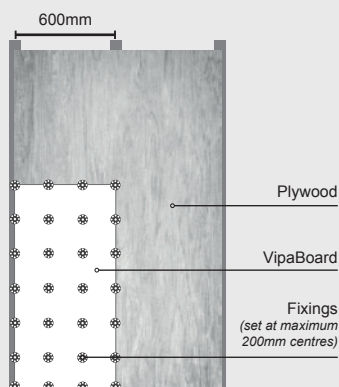

10mm/12.5mm VipaBoard fixed vertically over plywood lined studs set at 600mm centres.
(1200mm x 600mm VipaBoard)

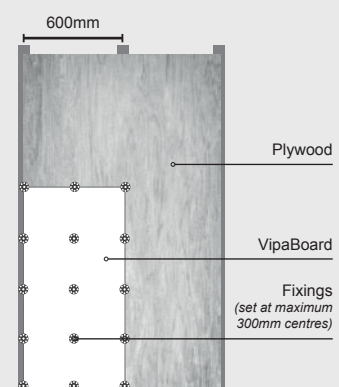

5. Fixing to External Stud Framework

Structural design consideration:

VipaBoard less than 12.5mm thick is not suitable for use onto external stud framework.

The external stud framework specification and any over cladding used must be designed and constructed in accordance with relevant building regulations. Depending on the design requirements, If the stud framework is pre clad, it may be necessary to fix 80mm wide fixing battens over the cladding, before fixing VipaBoard to form a ventilation cavity between the VipaBoard and the cladding. A moisture vapour membrane may also be required and must be considered as part of the design process before VipaBoard is applied.

5a) External Stud Framework

(Fix using 35mm diameter stainless- steel washers and screws)

Note: VipaBoard must be 12.5mm thick or greater for use on external stud framework

VipaBoard should be fixed using PCS 35mm diameter stainless-steel fixing washers and stainless-steel screws with a countersunk head. Anchor fixings into the stud/batten framework.

For Stud framework with vertical studs set at 300mm centres: Use minimum 12.5mm thick VipaBoard. Fix using 35mm diameter stainless steel washers and screws set vertically at 300mm centres. E.g. 15 Fixings per 1200mm x 600mm VipaBoard.

For Stud framework with vertical studs set at 400mm centres: Use minimum 20mm thick VipaBoard. Fix using 35mm diameter stainless steel washers and screws set vertically at 300mm centres. E.g. 12 Fixings per 1200mm x 600mm VipaBoard.

For Stud framework with vertical studs set at 600mm centres: Use minimum 30mm thick VipaBoard. Fix using 35mm diameter stainless steel washers and screws set vertically at 300mm centres. E.g. 10 Fixings per 1200mm x 600mm VipaBoard.

Fixing Coverage Guide

For 300mm stud framework centres with 12.5mm thick VipaBoard: 21 fixings per m²

For 400mm stud framework centres with 20mm thick VipaBoard: 17 fixings per m²

For 600mm stud framework centres with 30mm thick VipaBoard: 14 fixings per m²

Stud framework without cladding

Indicative Fixing Detail
using washers & screws
with 300mm Stud Centres
(1200mm x 600mm x 12.5mm VipaBoard)

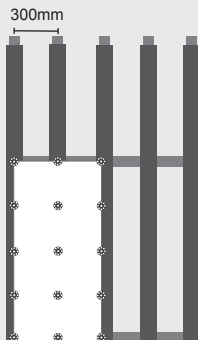

Stud framework with cladding & ventilation cavity

Indicative Fixing Detail
using washers & screws
with 400mm Stud Centres
(1200mm x 600mm x 20mm VipaBoard)

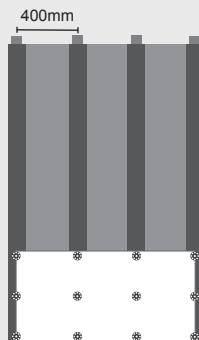

Indicative Fixing Detail
using washers & screws
with 600mm Stud Centres
(1200mm x 600mm x 30mm VipaBoard)

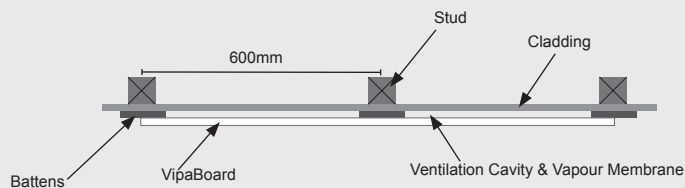
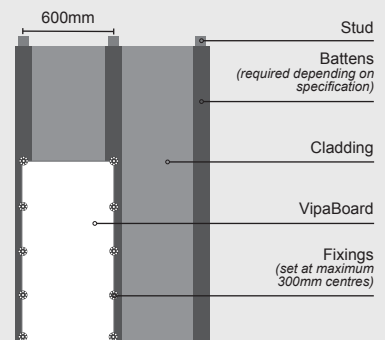

Cross section showing cladding with ventilation cavity

5b) External Stud Framework Clad in Cement Panelling

(fix with a solid adhesive bed and secure with 35mm diameter stainless- steel washers and screws)

Note: VipaBoard must be 12.5mm thick or greater.

VipaBoard should be fixed onto external cement panelling using a cement-based, flexible, tile adhesive that meets classification C2 S1 or above. The cement panels must be sealed with a suitable primer before cement adhesive is applied. In addition to the adhesive layer, 35mm diameter stainless-steel fixing washers and stainless-steel screws with a countersunk head must be used. The washers and screws must be fixed through the VipaBoard and cement cladding to anchor directly into the stud framework. The fixings should be positioned at maximum 300mm centres along the vertical studs of the framework.

The adhesive should be applied directly to the panelling using an 8-12mm notched tiling trowel, ensuring full coverage of the VipaBoard surface; solvent-based or ready mixed adhesives must NOT be used. In certain circumstances, for example uneven walls, it may be necessary to back butter the VipaBoard in addition to the adhesive applied to the substrate. Place the VipaBoard onto the wall surface, and bed firmly into place. Apply pressure to the VipaBoard surface making sure there is good compaction of the VipaBoard into the adhesive, and that no hollow spots remain under the VipaBoard. The adhesive layer will provide additional rigidity to the VipaBoard cladding.

Level the VipaBoards using a straight edge to ensure a flat uniform surface is achieved. Stagger VipaBoard joints by fixing the VipaBoard in a brick bond style.

Fixing Coverage Guide

Fixings	21 fixings + 4.5kg adhesive per m ² based on 300mm stud centres
	17 fixings + 4.5kg adhesive per m ² based on 400mm stud centres
	14 fixings + 4.5kg adhesive per m ² based on 600mm stud centres

Indicative Fixing Detail
using adhesive, washers & screws
based on 300mm stud centres
(1200mm x 600mm x 12.5mm VipaBoard)

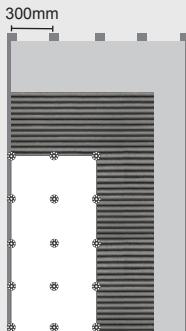

Indicative Fixing Detail
using adhesive, washers & screws
based on 400mm stud centres
(1200mm x 600mm x 12.5mm VipaBoard)

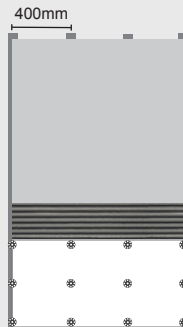

Indicative Fixing Detail
using adhesive, washers & screws
based on 600mm stud centres
(1200mm x 600mm x 20mm VipaBoard)

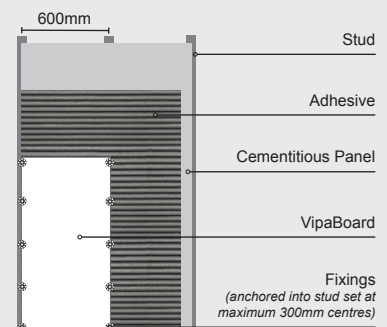

6. Fixing to Masonry Walls

Structural design consideration:

To fix VipaBoard onto walls above 2.4mtrs in height, mechanical fixing dowels and adhesive must be used.

For walls under 2.4mtrs VipaBoard can be fixed using adhesive without the need for fixing dowels.

For masonry walls that have a plaster or cement finish, adhesive and fixing dowels must be used. Fixing dowels must be of sufficient length to securely anchor into the masonry wall by a minimum 50mm. Ensure that the wall surface is stable, free of dust and grease, and that all loose and deleterious materials are removed to ensure good adhesion between the adhesive and the wall substrate.

Note: 4mm thick VipaBoard is not suitable for fixing onto walls.

VipaBoard 6mm thick and above is suitable for solid bed fixing onto masonry walls.

6a) Fixing onto Internal Masonry walls

(Fix using a solid adhesive bed. Fixing dowels will also be required if the wall has a cement or plaster finish)

Note: 4mm thick VipaBoard is not suitable for fixing onto walls.

VipaBoard 6mm thick and above is suitable for solid bed fixing onto masonry walls.

VipaBoard can be fixed onto clean internal masonry walls using a cement-based, flexible, fast setting tile adhesive that meets classification C2 S1 or above. The wall surface must be sealed with a suitable primer, prior to applying the cement adhesive.

The adhesive should be applied directly onto the wall using an 8-12mm notched tiling trowel, ensuring full coverage to the VipaBoard surface; solvent-based or ready mixed adhesives must NOT be used. In certain circumstances, for example uneven walls, it may be necessary to back butter the VipaBoard in addition to the adhesive applied to the substrate. Place the VipaBoard onto the wall surface, and bed firmly into place. Apply pressure to the VipaBoard surface, making sure there is good compaction of the VipaBoard into the adhesive, and that no hollow spots remain under the VipaBoard. Level the VipaBoards using a straight edge to ensure a flat uniform surface is achieved. Stagger VipaBoard joints by fixing the VipaBoard in a brick bond style.

DO NOT ALLOW THE ADHESIVE TO FORM A SKIN AS THIS WILL PREVENT ADHESION.

6b) Fixing onto Internal Masonry Walls with Gypsum/ Cement Finishes

Note: 4mm thick VipaBoard is not suitable for fixing onto walls.

VipaBoard 6mm thick and above is suitable for solid bed fixing onto masonry walls.

For internal masonry walls that have a gypsum or cement finish and is in a good condition, it may be possible to fix the VipaBoard onto the wall without removing the existing finishes; however professional advice on the stability of the wall structure and wall finishes should be sought. All masonry, cement, and gypsum wall surfaces must be sealed with a suitable primer, prior to applying the cement adhesive.

Fix VipaBoard over the cement/plaster finishes using a flexible, fast setting tile adhesive that meets classification C2 S1 or above. The adhesive should be applied to the wall surface using an 8-12mm notched tiling trowel, ensuring full coverage of the VipaBoard surface; solvent-based or ready mixed adhesives must NOT be used. In certain circumstances, for example uneven walls, it may be necessary to back butter the VipaBoard in addition to the adhesive applied to the substrate.

In addition, once the adhesive has set, VipaBoards MUST be fixed with PCS fixing dowels set at 400mm - 600mm centres (e.g. 8 dowels per 1200mm x 600mm VipaBoard).

Position the fixing dowels along the VipaBoard edge and also along the centre line of each VipaBoard. The fixings placed along the centre of the VipaBoard should be staggered from the VipaBoard edge fixings, creating a crisscross pattern on the VipaBoard surface.

Additional fixings can be used to secure the VipaBoard firmly to the wall substrate.

DO NOT ALLOW THE ADHESIVE TO FORM A SKIN AS THIS WILL PREVENT ADHESION.

Fixing Coverage Guide

Adhesive: 4.5kg per m²

Fixings Dowels: 12 per m²

(fixing quantities may be reduced if Dowels are used to span adjacent VipaBoards)

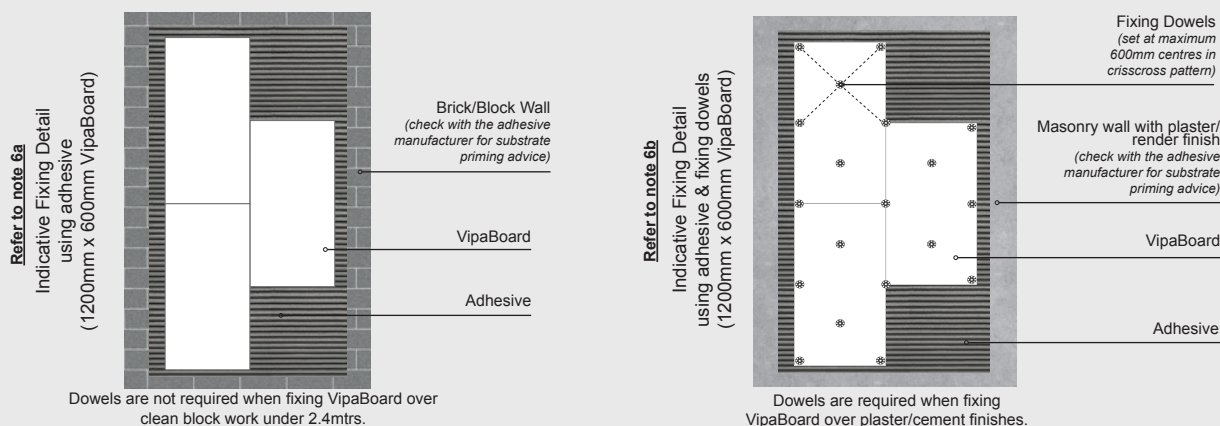

6c) Fixing onto External Masonry walls

Fix using a solid adhesive bed and secure with fixing dowels)

To fix VipaBoard onto walls above 2.4mtrs in height, mechanical fixing dowels and adhesive must be used.

For walls under 2.4mtrs VipaBoard can be fixed using adhesive without the need for fixing dowels.

Fixing dowels must be of sufficient length to securely anchor into the masonry wall by a minimum 50mm.

Ensure that the wall surface is stable, free of dust and grease, and that all loose and deleterious materials are removed to ensure good adhesion between the adhesive and the wall substrate.

Note: 4mm thick VipaBoard is not suitable for fixing onto walls.

VipaBoard 6mm thick and above is suitable for solid bed fixing onto masonry walls.

VipaBoard can be fixed onto clean external masonry walls using a solid bed of cement-based, flexible, tile adhesive that meets classification C2 S1 or above. When Fixing VipaBoard onto external masonry walls that extend above 2.4mtrs height, in addition to the solid adhesive bed, the VipaBoard must also be secured with fixing dowels once the adhesive has set. Fixing dowels should be set at 400mm and 600mm centres (e.g. 8 fixings per 1200mm x 600mm VipaBoard). Seal the wall with a suitable water-resistant primer, before the adhesive is applied. The adhesive should be applied directly onto the wall using an 8-12mm notched tiling trowel, ensuring full coverage to the VipaBoard surface; solvent-based or ready mixed adhesives must NOT be used. In certain circumstances, for example uneven walls, it may be necessary to back butter the VipaBoard in addition to the adhesive applied to the substrate.

Place the VipaBoard onto the wall surface, and bed firmly into place. Apply pressure to the VipaBoard surface, making sure there is good compaction of the VipaBoard into the adhesive, and that no hollow spots remain under the VipaBoard. Level the VipaBoards using a straight edge to ensure a flat uniform surface is achieved. Stagger VipaBoard joints by fixing the VipaBoard in a brick bond style. Position the fixing dowels (required above 2.4mtrs) along the VipaBoard edge and also along the centre line of each VipaBoard. The fixings placed along the centre of the VipaBoard should be staggered from the VipaBoard edge fixings, creating a crisscross pattern on the VipaBoard surface.

Additional fixings can be used to secure the VipaBoard firmly to the wall substrate.

DO NOT ALLOW THE ADHESIVE TO FORM A SKIN AS THIS WILL PREVENT ADHESION.

Fixing Coverage Guide
Adhesive: 4.5kg per m ²
Fixings: 12 per m ² <i>(fixing quantities may be reduced if washers are used to span adjacent VipaBoards)</i>

Indicative Fixing Detail
using adhesive and fixing dowels.
(1200mm x 600mm VipaBoard)

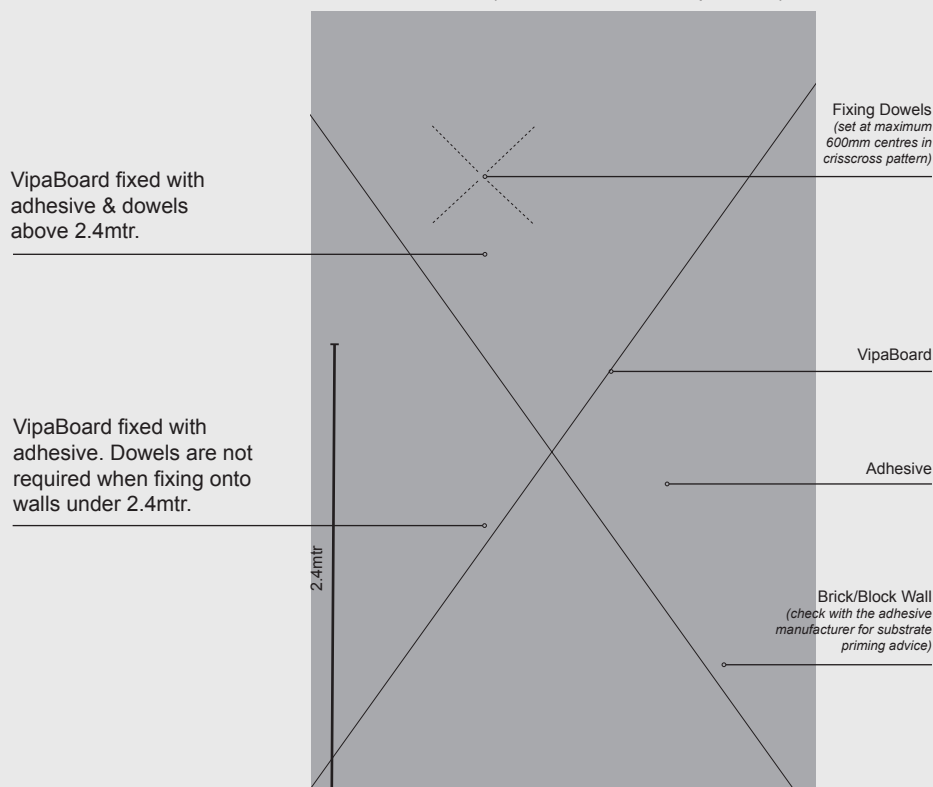

6d) Dot and Dab onto Masonry Walls (internal walls only)

(fix with cement-based adhesive dots and secure with fixing dowels. **DRYWALL ADHESIVE MUST NOT BE USED.**

Note: VipaBoard must be 12.5mm thick or greater for fixing with Dot and Dab method.

Make sure that the existing wall surface is stable and free of dust and grease. If the wall has a pre-finished surface e.g. plaster/render, and is in a good condition, it may be possible to adhere the VipaBoard without removing the existing finish, however professional advice on the stability of the existing finishes and wall structure should be sought. All masonry walls, and cement and plaster finishes must be sealed with a suitable primer before cement adhesive is applied. To fix VipaBoard to walls, the dot and dab material used, must be cement-based, flexible, fast setting tile adhesive that meets classification C2 S1 or above.

The adhesive dots must be applied directly to the VipaBoard with dots set at a maximum 300mm apart. A useful tip is to create a pre-set hole through the face of the VipaBoard to show where the fixing dowels will be placed once adhesive has set. To avoid adhesive shrinkage, the tile adhesive dots must not exceed 15mm once compressed to the wall substrate. Place the VipaBoard onto the wall surface, and bed firmly into place in a brick bond style, levelling the VipaBoard surface with adjacent VipaBoard as you proceed. Apply pressure to the VipaBoard surface making sure there is good compaction of the VipaBoard onto the wall. In addition to the adhesive dots, VipaBoards must be secured using fixing dowels anchored with a minimum 50mm embedment into the masonry wall. Position the dowels through the centre of the adhesive dots once the adhesive has set.

Place dowels at between 400mm and 600mm centres (e.g. 8 fixings per 1200mm x 600mm VipaBoard). Position the fixing dowels along the VipaBoard edge and also down the centre line of each VipaBoard. The fixing dowels placed down the centre of the VipaBoard should be staggered from the VipaBoard edge dowels, creating a crisscross pattern on the VipaBoard surface.

Additional fixings can be used to secure the VipaBoard firmly to the wall substrate.

Fixing Coverage Guide	
Adhesive	6kg per m ²
Fixings	12 per m ²

Indicative Fixing Detail
using adhesive dots and fixing dowels
(2400mm x 600mm VipaBoard)

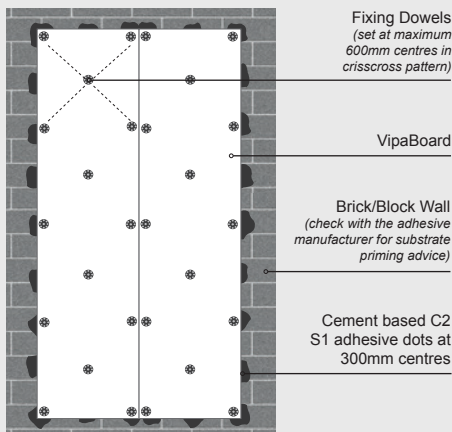

Indicative Fixing Detail
using adhesive dots and fixing dowels
(1200mm x 600mm VipaBoard)

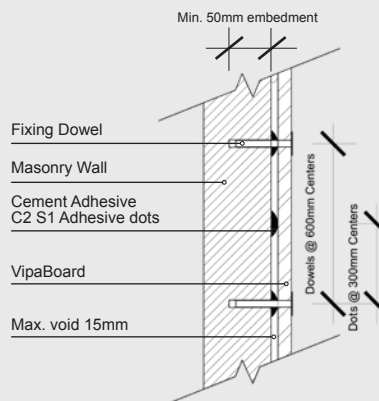
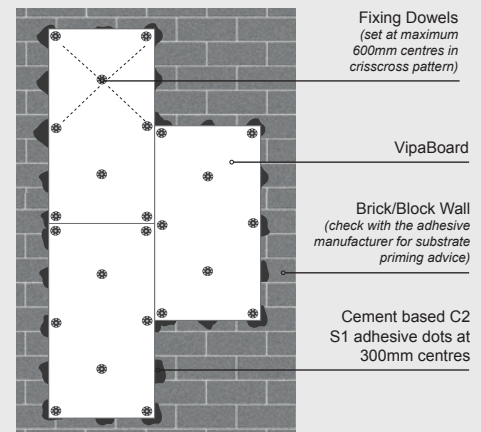

Cross section showing dowels fixed through adhesive dots.

7. Taping Joints, Abutments and Fixings

All VipaBoard joints, abutments and mechanical fixings must be bridged with a joint reinforcing tape, suitable for the intended use and the environment in which the VipaBoard is to be installed.

For VipaBoard fixed in dry zones: Tape all joints, fixing washers, and holes in the VipaBoard using an alkaline resistant mesh such as VipaBoard Jointing Tape.

For VipaBoard fixed in wet zones: Tape all joints, fixing washers, and holes in the VipaBoard with PCS Waterproofing Paste and PCS Waterproofing Tape.

PCS Waterproofing Paste is a brush applied liquid waterproofing membrane designed for use under tiles. Tiles should be fixed over PCS Waterproofing Paste & Tape using a cement-based tile adhesive that meets classification C2 S1 or above. Solvent based, ready mixed and epoxy-based adhesives should not be used over the PCS Waterproofing Paste and Tape.

Solvent free epoxy grout, that meets classification R2, can be used to grout tiles that have been fixed over PCS Waterproofing Paste with a cement based C2 S1 adhesive.

8. PCS Waterproofing Paste

Although VipaBoard is 100% waterproof, moisture vapour can pass through the VipaBoard structure, when exposed to extremely high humidity over prolonged periods in environments such as steam rooms. To protect the VipaBoard against moisture vapour penetration in such harsh environments, we recommend applying PCS Waterproofing Paste over the entire surface of the VipaBoard. Covering all joints, abutments and fixings with PCS Waterproofing Paste & Tape, will provide an effective vapour barrier with a moisture resistance value of $\mu 41400$, prior to fixing tiles.

Domestic showering and bathing environments are not usually subject to prolonged high levels of humidity, and therefore, only require the board joints and fixings to be covered with PCS Waterproofing Paste and Tape. PCS Waterproofing Paste is very easy to apply using a paint brush or roller. The instruction guidance supplied with the PCS Waterproofing Paste must be followed.

PCS Waterproofing Paste is designed for use under tiles. Tiles should be fixed over the PCS Waterproofing Paste and Tape using a cement-based tile adhesive that meets classification C2 S1 or above. Solvent based, ready mixed and epoxy-based adhesives should not be used over the PCS Waterproofing Paste. Solvent free epoxy grout, that meets classification R2, can be used to grout tiles that have been fixed over PCS Waterproofing Paste with a cement based C2 S1 adhesive.

9. Expansion/Movement Joints

VipaBoard must not bridge expansion/movement joints. The integrity of such joints should be maintained through the VipaBoard and tile bed and should be sealed in the appropriate manner.

10. VipaBoard with Soft Floor Finishes

(Carpet, Vinyl floors, Vinyl tiles, Karndean, Amtico etc)

When installing soft floor coverings over VipaBoard, it is essential that the surface of the VipaBoard is covered with a minimum 10mm thick hard-wearing, cement-based, flexible, levelling screed, capable of resisting high point loading. Tape all VipaBoard Joints before applying the levelling screed. The cement levelling screed must be left to cure before floor finishes are applied.

Note: VipaBoard is not compatible with solvent based adhesives. If solvent adhesive is required to fix floor finishes over VipaBoard, the surface of the VipaBoard must be covered with a cement based, flexible, levelling screed, applied at a minimum thickness of 10mm. For floor finishes where solvent based adhesive is to be used, care must be taken to ensure that the solvent adhesive does not come into contact with the VipaBoard.

11. VipaBoard with Wood Planking/Laminate Planking Floor Finishes (Floating Floor)

For domestic projects, if the floor is flat and level wood planking/laminate planking can be fitted directly over VipaBoard.

Lay the wood planking/laminate planking after fitting a foam underlay over the surface of VipaBoard. The type of underlay used will depend on the type of wood planking/laminate planking used. It is important to use a low thermal resistant underlay if underfloor heating is present.

When installing wood planking/laminate planking over VipaBoard on commercial projects, the VipaBoard surface must be covered with a minimum 7mm thick, hard-wearing, cement-based, flexible, levelling screed, capable of resisting high point loading.

Tape all Board Joints before applying the levelling screed. The cement levelling screed must be allowed to cure before floor finishes are applied.

12. VipaBoard with Solid Wood Planking/Wood Blocks fixed using Adhesive (Solid Floor)

When fixing Solid Wood finishes over VipaBoard, the surface of the VipaBoard must be covered with a minimum 7mm thick hard-wearing, cement-based, flexible, levelling screed, capable of resisting high point loading. The cement screed must be allowed to cure before floor finishes are applied. Fix the Solid Wood onto the levelling screed in accordance with the solid wood manufacturer's instructions.

Note: VipaBoard is not compatible with solvent based adhesives. If solvent adhesive is required to fix floor finishes over VipaBoard, the surface of the VipaBoard must be covered with a cement based, flexible, levelling screed, applied at a minimum thickness of 7mm. For applications where solvent based adhesive is to be used, care must be taken to ensure that the solvent adhesive does not come into contact with the VipaBoard.

13. VipaBoard with Under Floor Heating

VipaBoard is a thermally insulating construction board, and when installed below underfloor heating will improve the heating system performance by significantly reducing downward heat loss. VipaBoard is compatible for use with water based and electric cable underfloor heating systems. VipaBoard must not be fixed over floors that have an existing underfloor heating system installed.

14. Tile Choice for Floors

When choosing tiles for your floor it is important to consider point loading. Applying larger tiles improves the VipaBoards resistance to concentrated loads. For areas that may be subject to concentrated loads over 0.21 N/mm², advice should be sought to determine suitability. All tiles must be fixed using a solid bed of adhesive, ensuring no voids remain under the tiles. Tiles should be fixed using good quality, flexible cement-based tile adhesive that meets classification C2 S1 grade or above. Solvent-based or Ready Mixed adhesives MUST NOT be used. The chart below shows resistance to concentrated loads based on a 1mm deflection over a range of standard tile sizes.

Indicative Tile Size Examples	300mm x 200mm	150mm x 150mm	100mm x 100mm	50mm x 50mm
Load Resistance Over Tile Surface	1260kg	472kg	210kg	52.5kg

15. Tile fixing to Walls

Tiles can be fixed directly to VipaBoard using a good quality cement-based, flexible tile adhesive that meets classification C2 S1 grade or above. Solvent-based or ready mixed adhesives MUST NOT be used.

Advice from the tile manufacturer must be sought regarding the mechanical securing and fixing of tiles onto walls above 2.4mtr.

16. Plastering

All joints, abutments and fixings, must be bridged with a suitable joint reinforcing mesh such as VipaBoard Jointing Tape. Prior to skim coating with plaster, the surface of the VipaBoard must be sealed using a suitable primer, applied in accordance with the manufacturer's instructions.

17. Flexible Synthetic Render Systems

VipaBoard is compatible for highly flexible synthetic render systems that require the application of a reinforcing base layer and a reinforcing mesh, before a final finishing coat is applied. Traditional sand & cement-based render systems are not compatible for use with VipaBoard.

Advice and guidance must be sought from the manufacturer regarding the preparation of the VipaBoard before applying external render.

NOTE: VipaBoard must be stored flat at all times, leaning the VipaBoard against a wall can cause them to warp slightly prior to installation. If this occurs, they can be straightened by applying a minimal amount of hand pressure. This correction will not affect the performance of the VipaBoard. When fixing VipaBoard in conditions where temperatures can fluctuate considerably it will be necessary to protect the boards from extreme temperature fluctuations, allowing any adhesive used to set properly.

Building Regulations

All information is given as guidance and if adhered to will perform as intended. We fully guarantee the quality of our products, however, as we do not have knowledge of site conditions or the capability of the installer, we cannot accept liability for damage which may arise due to a result of incorrect installation. The information and advice provided by PCS does not override nor supersede building regulations. It is the responsibility of the user to seek professional guidance to ensure PCS products are compatible for their intended use and that the products comply with building regulations.

The Professionals Choice



PCS

High
Performance
Construction
Products

PCS Ltd
Hemfield Court, Makerfield Way,
Ince, Wigan, WN2 2PR

Tel: +44 (0) 1942 820131

Web: www.pcsboard.com

Rev: 02/24